

Product Evaluation Report
RPS METAL ROOFING & SIDING, INC.

26 Ga. Super Pro PBR Roof Panel over open framing

Florida Product Approval # 4574.3 R5

Florida Building Code 2017

Per Rule 61G20-3

Method: 1 –D

Category: Structural Components

Subcategory: Roof Deck

Compliance Method: 61G20-3.005(1)(d)

NON HVHZ

Product Manufacturer:

RPS Metal Roofing & Siding, Inc.

302 4th Ave.

Welaka, FL 32193

Engineer Evaluator:

Terrence E. Wolfe, P.E. # 44923

Florida Evaluation ANE ID: 1920

Validator:

Brian Jaks P.E. #70159

Contents:

Evaluation Report Pages 1 – 4

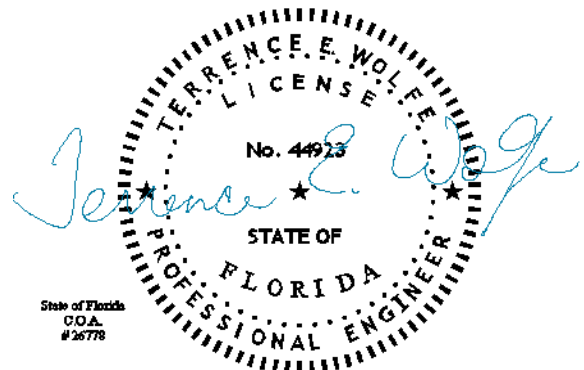

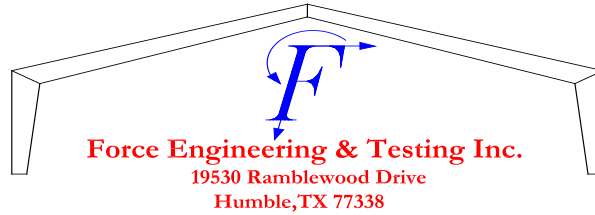

Compliance Statement: The product as described in this report has demonstrated compliance with the Florida Building Code 2017, Sections 1504.3.2, 1504.7.

Product Description: Super Pro PBR Roof Panel, 26 Ga. Steel, 36" Wide, through fastened structural roof panel. Structural Application.

Panel Material/Standards: Material: 26 Ga. Steel, ASTM A792 or ASTM A653 G90 conforming to Florida Building Code 2017 Section 1507.4.3.
Yield Strength: Min. 80.0 ksi
Corrosion Resistance: Panel Material shall comply with Florida Building Code 2017, Section 1507.4.3.

Panel Dimension(s): Thickness: 0.0185" min.
Width: 36" maximum coverage
Rib Height: 1 1/4" major rib at 12" O.C.

Panel Fastener: #12-14 x 1-1/4" Steelbinder HWH SD with sealing washing or approved equal.
1/4-14 x 7/8" Steelbinder HWH Stitch with sealing washer through panel side laps at 20" O.C.
Corrosion Resistance: Per Florida Building Code 2017, Section 1507.4.4.

Substrate Description: Min. 16 Ga. Steel Framing. Framing must be designed in accordance w/ Florida Building Code 2017.

Allowable Design Pressures:

Table "A"

Maximum Design Pressure:	-36.4 psf	+46.9 psf	-111.9 psf	+165.0 psf
Fastener Pattern:	12"-12"-12"	12"-12"-12"	12"-12"-12"	12"-12"-12"
Fastener Spacing:	5'-0" O.C.	5'-0" O.C.	2'-0" O.C.	2'-0" O.C.

*Design Pressure includes a Safety Factor = 2.0

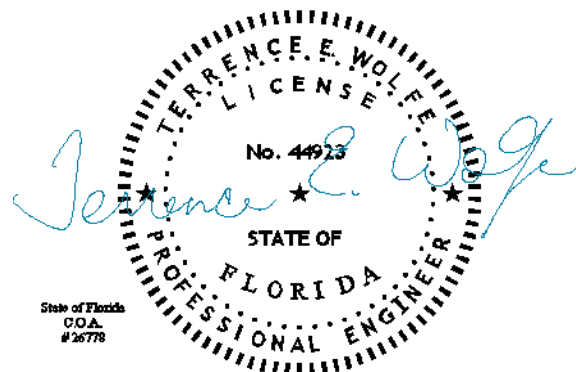

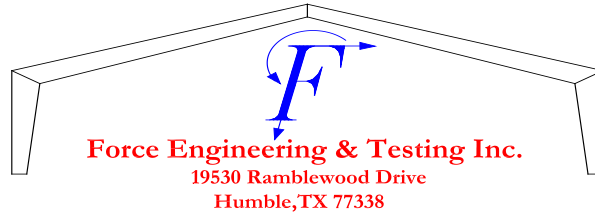

- Code Compliance:** The product described herein has demonstrated compliance with The Florida Building Code 2017, Section 1504.3.2, 1504.7.
- Evaluation Report Scope:** The product evaluation is limited to compliance with the structural wind load requirements of the Florida Building Code 2017, as relates to Rule 61G20-3.
- Performance Standards:** The product described herein has demonstrated compliance with:
- ASTM E 1592-05 (2012) Test method for structural performance of sheet metal roof and siding systems by uniform static air pressure difference.
 - FM 4471-92, Foot Traffic Resistance Test.
- Reference Data:**
1. ASTM E 1592-05 (2012)
Force Engineering & Testing, Inc. (FBC Organization # TST-5328)
Report No. 118-0036T-19A-D
 2. FM 4471-10, Section 4.4 Foot Traffic Resistance Test
Force Engineering & Testing, Inc. (FBC Organization # TST-5328)
Report No. 118-0036T-19E
 3. Certificate of Independence
By Terrence E. Wolfe, P.E. (No. 44923) @ Force Engineering & Testing, Inc.
(FBC Organization # ANE ID: 1920)
- Test Standard Equivalency:** The FM 4471-10, Foot Traffic Resistance test standard is equivalent to FM 4471-92.
- Quality Assurance Entity:** The manufacturer has established compliance of roof panel products in accordance with the Florida Building Code and Rule 61G20-3.005 (3) for manufacturing under a quality assurance program audited by an approved quality assurance entity.
- Minimum Slope Range:** Minimum Slope shall comply with Florida Building Code 2017, including Section 1507.4.2 and in accordance with Manufacturers recommendations. For slopes less than 3:12, lap sealant must be used in the panel side laps.
- Installation:** Install per manufacturer's recommended details.
- Insulation:** Manufacturer's approved product (Optional)
- Roof Panel Fire Classification:** Fire classification is not part of this acceptance.

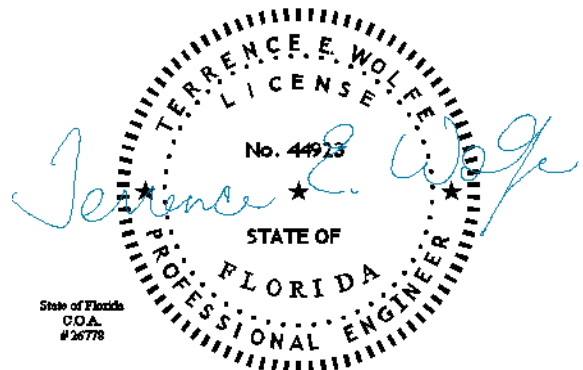

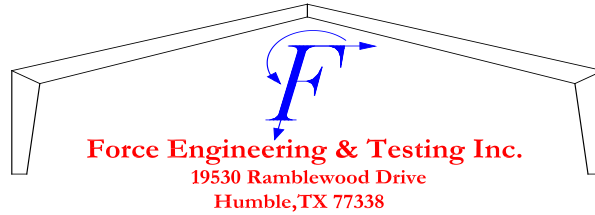

Shear Diaphragm:

Shear diaphragm values are outside the scope of this report.

Design Procedure:

Based on the dimensions of the structure, appropriate wind loads are determined using Chapter 16 of the Florida Building Code 2017 for roof cladding wind loads. These component wind loads for roof cladding are compared to the allowable pressure listed above. The design professional shall select the appropriate erection details to reference in his drawings for proper fastener attachment to his structure and analyze the panel fasteners for pullout and pullover. Support framing must be in compliance with Florida Building Code 2017 Chapter 22 for steel, and Chapter 16 for structural loading.

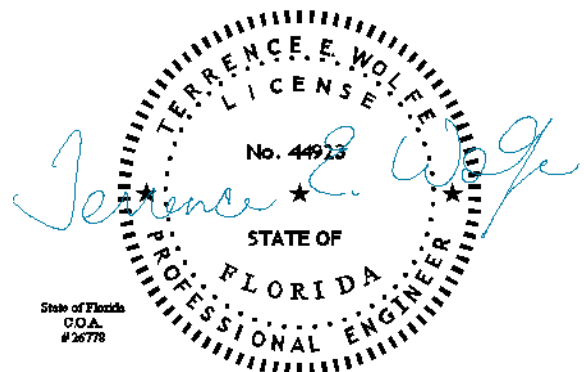

FASTENER PATTERN

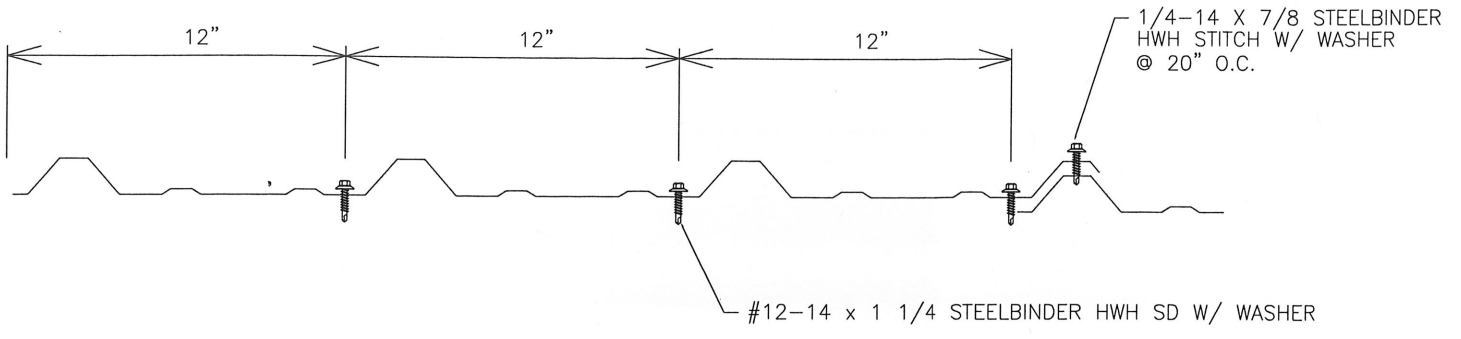

APR 16 2019

State of Florida
C.O.A.
26778

Terrence E. Wolf

